

## FITTING INSTRUCTION

Clamp mark in acc. with		Cables joining
ISO	PN	
1	L	Left directional lights
2	+	Rear fog lights
3	31	Ground
4	R	Right directional lights
5	58R	Right side parking lights
6	54	Stoplights
7	58L	Left side parking lights

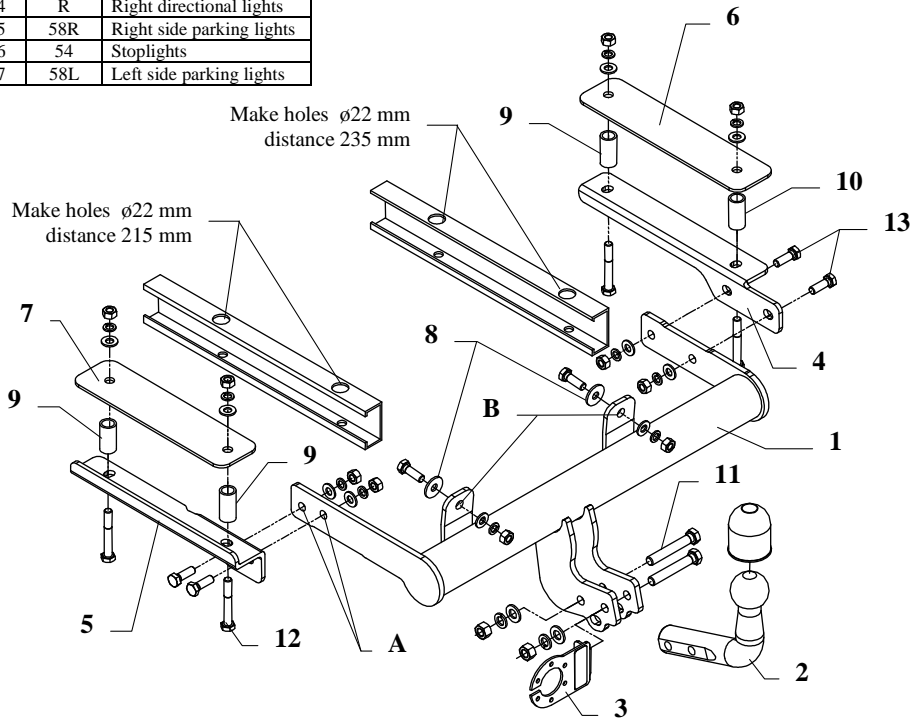

This towbar is designed to assembly in following car:  
**CITROEN SAXO 3-5 doors**, produced since 1996 till 2004, catalogue no.  
**P09** and is prepared to tow trailers max total weight **1100kg** and max  
 vertical load **50 kg**.

### *From manufacturer*

Thank you for buying our product. Their reliability has been confirmed in many tests. Reliability of towbar depends also on correct assembly and right operation. For this reasons we kindly ask to read carefully this instruction and apply to hints.

*The towbar should be install in points described by a car producer.*

## The instruction of the assembly

1. Unscrew spare wheel and heat protection, next unfasten to the muffler (secure to tear off).
2. From below the car through existing holes in chassis members:
  - from the right side with distance 235 mm
  - from the left side with distance 215 mm
 very carefully mark and next drill using bit  $\varnothing 22\text{mm}$  (from the trunk).
3. In made holes put distance sleeves (as in the drawing), next put elements (pos.6 and 7) and bolts M10x70mm (pos. 12).
4. From below the car on protruding bolts put on side brackets (pos. 4 and 5) and loosely fix using nuts from accessories.
5. Fix the main bar of the towbar (pos. 1) with side brackets (through holes pos. A) using bolts M10x30mm (pos. 13), and next through existing holes in rear piece and holes (pos. B) fix all using bolts M10x30mm (do not forget about washers – pos. 8)
6. Tighten all bolts according to the torque shown in the table.
7. Fix tow-ball (pos. 2) and the socket plate (pos. 3) using bolts M12x75mm (pos. 11) from accessories.
8. Connect electric wires according to the instruction of the car. (Recommend to make at authorized service station).
9. Supplement the paint coating damaged during assembly.

Torque settings for nuts and bolts (8,8):	
<b>M 8 - 25 Nm</b>	<b>M 10 - 55 Nm</b>
<b>M 12 - 85 Nm</b>	<b>M 14 - 135 Nm</b>











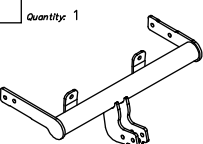



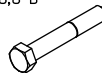

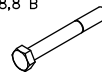

### NOTE

After install the towbar you should get adequate note in registration book (at authorised service station).The car should be equipped with:

- Indicators
- Tow mirrors

After 1000km of exploitation check all bolts and nuts. The ball of towbar must be always kept clear and conserve with a grease.

## Towbar accessories:

Pos. 1 Name: Main bar Quantity: 1 	Pos. 5 Name: Left bracket Quantity: 1 Dim.: L=300mm 	Pos. 10 Name: Distance sleeve Quantity: 1 Dim.: Ø21,3x2,65 L=40mm 	Pos. 15 Name: Nut 8 B Quantity: 10 Dim.: M10 
	Pos. 6 Name: Right fish-plate Quantity: 1 Dim.: 295x70mm 	Pos. 11 Name: Bolt 8,8 B Quantity: 2 Dim.: M12x75mm 	Pos. 16 Name: Plain washer Quantity: 2 Dim.: Ø 13 mm 
Pos. 2 Name: Tow ball Quantity: 1 	Pos. 7 Name: Left fish-plate Quantity: 1 Dim.: 275x70mm 	Pos. 12 Name: Bolt 8,8 B Quantity: 4 Dim.: M10x70mm 	Pos. 17 Name: Plain washer Quantity: 10 Dim.: Ø 10,5 mm 
Pos. 3 Name: Socket plate Quantity: 1 	Pos. 8 Name: Plain washer Quantity: 2 Dim.: Ø30xØ10,5x2,5mm 	Pos. 13 Name: Bolt 8,8 B Quantity: 6 Dim.: M10x30mm 	Pos. 18 Name: Spring washer Quantity: 2 Dim.: Ø 12,2 mm 
Pos. 4 Name: Right bracket Quantity: 1 Dim.: L=365mm 	Pos. 9 Name: Distance sleeve Quantity: 3 Dim.: Ø21,3x2,65 L=43mm 	Pos. 14 Name: Nut 8 B Quantity: 2 Dim.: M12 	Pos. 19 Name: Spring washer Quantity: 10 Dim.: Ø 10,2 mm 
			Pos. 20 Name: Ball cover Quantity: 1 



## PPUH AUTO-HAK Sp.J.

Produkcja Zaczepów Kulowych  
Henryk & Zbigniew Nejman  
76-200 SŁUPSK ul. Słoneczna 16K  
tel/fax (059) 8-414-414; 8-414-413  
E-mail: office@autohak.com.pl  
www. autohak.com.pl

## Towing hitch (without electrical set)

Class: **A50-X** Cat. no. **P09**

Designed for:

Manufacturer: **CITROEN**

Model: **SAXO**

Type: **3-5 doors**

produced since 1996 till 2004

Technical data:

**D-value: 6,04 kN**

maximum trailer weight: **1100 kg**

maximum vertical cup load: **50 kg**

**Approval number acc. to regulations EKG/ONZ 55.01: E20-55R-01 1076**

## Foreword

This towbar is designed according to rules of safety traffic regulations. The towing hitch is a safety component and can be install only by qualified personnel. Any alteration or conversion of the towing hitch is prohibited and would lead to cancellation of design certification. Remove insulating compound and underseal from vehicle (if present) in the area of the matting surfaces of the towing hitch. The vehicle manufacturer's specifications regarding trailer load and max. vertical cup load are decisive for driving, and values for the towing hitch cannot be exceeded.

*D-value formula:*

$$\frac{\text{Max trailer weight [kg]} \times \text{Max vehicle weight [kg]}}{\text{Max trailer weight [kg]} + \text{Max vehicle weight [kg]}} \times \frac{9,81}{1000} = D \text{ [kN]}$$



[ahkupplungen.de](http://ahkupplungen.de)